HS5000 INSTALLATION GUIDE

Contents

| | |
|----------------------------------|----|
| Plan the Installation | 1 |
| Rough-In | 2 |
| Determine Valve Height | 2 |
| New Construction | 3 |
| Pipe Run Dos & Don'ts | 4 |
| Low Voltage Wire | 6 |
| Test The System | 6 |
| Typical Pipe Runs | 7 |
| Trim | 8 |
| Retro-fit an Existing Home | 10 |
| Addendum (100716)..... | 11 |

*** IMPORTANT ***

This Manual assumes that the installer has working knowledge and experience installing traditional Central Vacuum Systems.

It is critical that only parts supplied by Hide-a-Hose Inc. be used in the installation.

Parts include screws, seals, washers, hoses, sweep 90's, 45's, etc.

Failure to use these parts will void any warranty offered by the manufacturer.

Installers are responsible for adhering to all local building codes.

Plan the Installation

Planning is the key to the successful installation of a central vacuum system. A balance between the best locations for the inlet valves and the practicality of installing in those locations must be obtained. With a little ingenuity most locations can be reached.

*** IMPORTANT ***

The maximum wall thickness the valve can work with is 1.5 inches (3.8 cm).

Hose Lengths

Let the customer know that you will custom size the hose to fit each floor. Hose kits come in 30, 40, 50, or 60 foot (9.1, 12.2, 15.2, 18.3 meter) lengths.

Power Unit Selection

It is important to keep in mind that air flow is reduced with longer hoses. To compensate for the loss of air flow, a larger power unit is required.

Valve locations

A 50' (15.2 m) hose will usually cover between 1800-2300 sq ft (549-701 sq m). Placement of the inlets should, if possible, be located in a hallway or in other areas that do not have high visibility.

Plan pipe runs

Carefully read the section in this guide on "pipe runs". There are also diagrams showing four typical pipe runs.

Rough-In

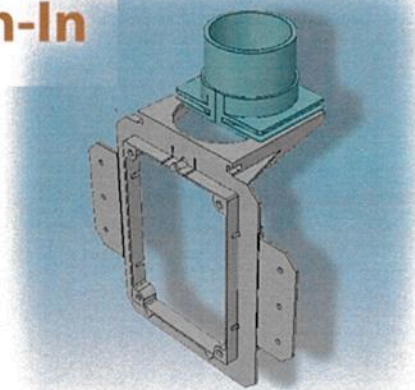

Determine Valve Height

Down Orientation

In a down orientation (tubing is being run in the crawl space), align the bottom of the valve with the height of the electrical plug outlets (about 11 inches or 27.9 cm). Mounting the valve higher in a down orientation creates a more difficult angle for the hose to retract.

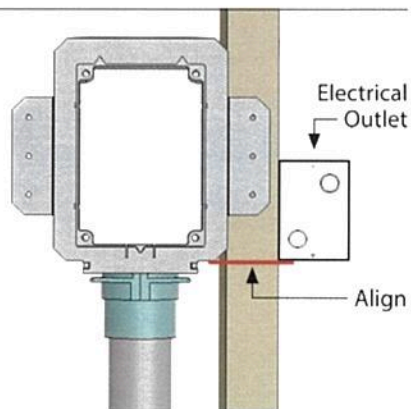

Up Orientation

In an up orientation (hose exiting the valve towards the ceiling), most people find it more convenient with the valve mounted at the height of the light switch outlet.

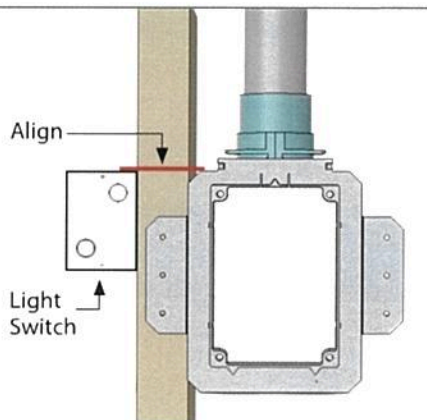

New Construction

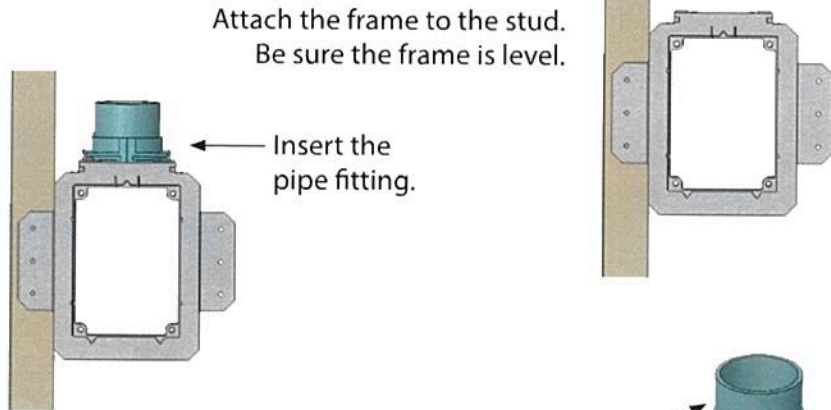

The pipe fitting is designed to slide in the frame to adjust for variations in wall board thickness.
The maximum wall thickness the valve can work with is 1.5 inches (3.8 cm).

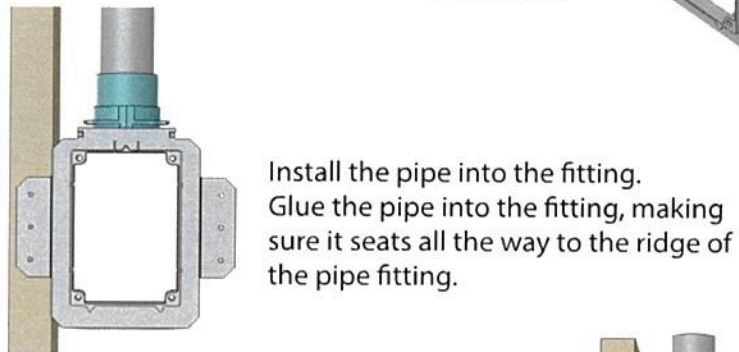
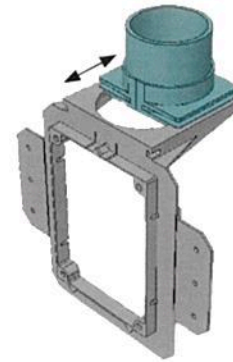

Install the mud cover.

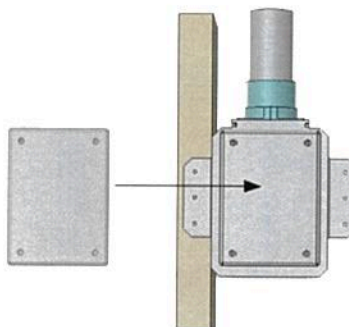

Pipe Run Dos & Don'ts

Refer to the diagrams on pages 6-8.

Unlike a traditional install, do not join pipe runs until you have enough pipe length to hold the hose. For example, if using a 40' (12.2 m) hose, install at least 44' (13.4 m) of pipe before connecting to another pipe run.

In order to ensure enough pipe to store the hose, the pipe runs will sometimes need to begin running away from the power unit, then make a loop and head back to the power unit.

Any burr or excess glue glob can snag and damage the hose sock as it travels through the tubing. To prevent this, be sure to always glue the pipe and not the fittings. Make sure to remove all burrs from the pipe ends that were cut. Carefully inspect the pipe to make sure the inside is smooth and that the pipe is round and undamaged.

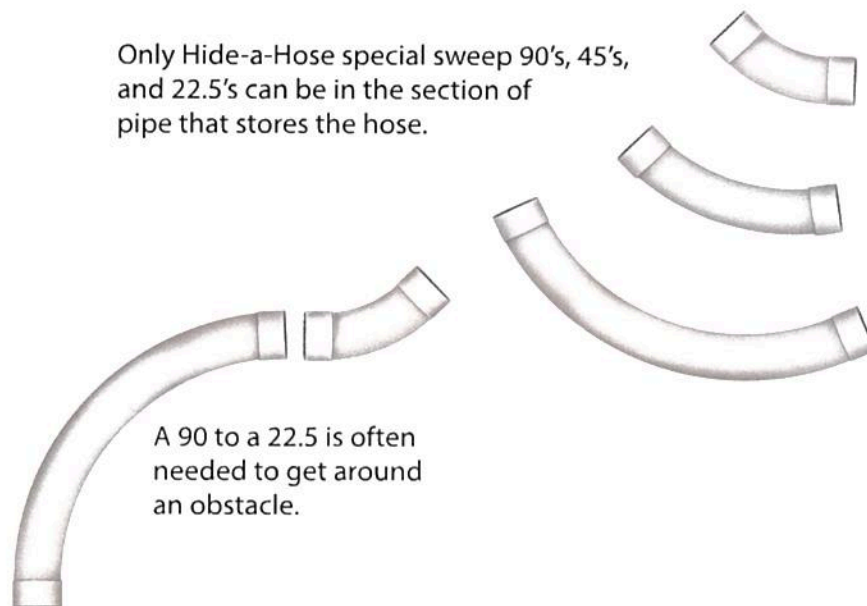

Try to space out 90's as much as possible.

The more 90's used, the more force is needed to pull the hose out of the wall. Try not to use more than four 90's for each valve.

Try to avoid back to back 90's, if at all possible.



It is important to design the pipe runs so the hose is stored on one plane.

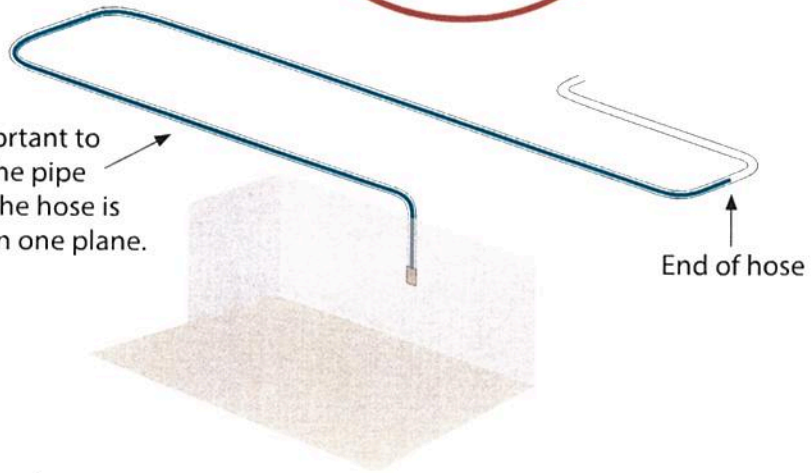

Hose stored on two different planes.

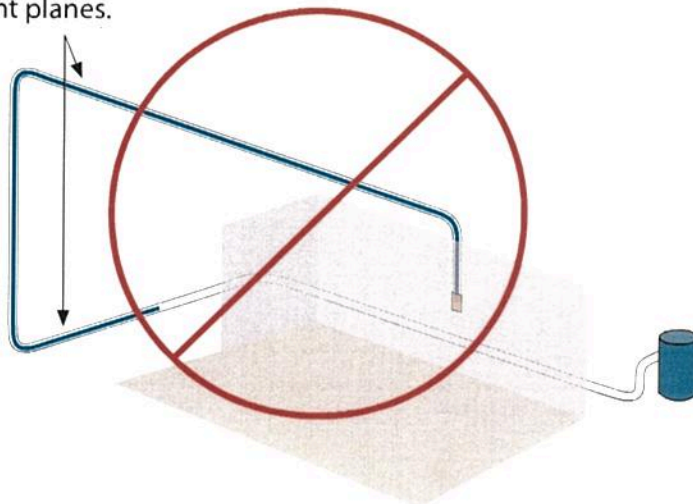

When using the Rapid Flex hose, we recommend installation of a reducer in the pipe run, before the first standard fitting. This prevents the possibility of the hose getting stuck in a tight fitting, if it stretches when retracted. See diagram below for positioning.

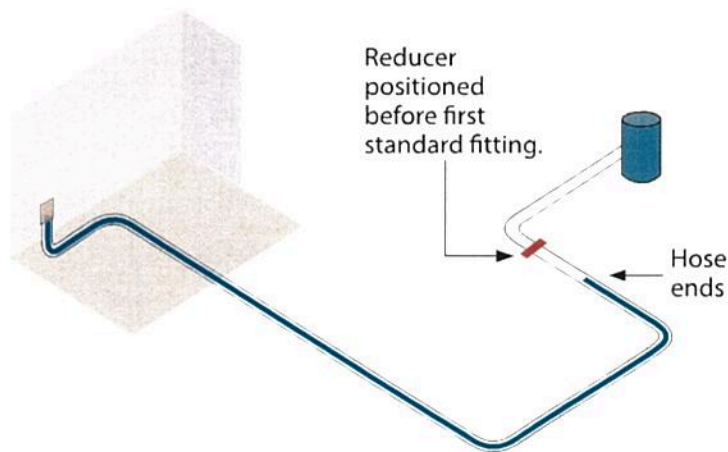
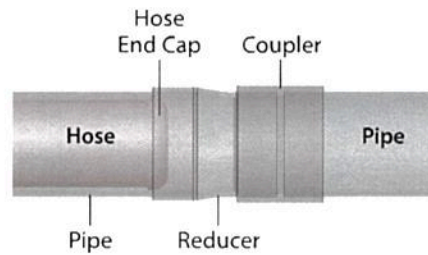

Low Voltage Wire

Run low voltage wire to each inlet, just as you would with a standard central vacuum install.

Test the System

It is a good idea to test the system by retracting a hose before the walls are sheetrocked.

Since the doors are needed to seal the system, a hand ball can be placed over each valve opening that is not being tested to seal the system. In an up orientation, you will need to tape the hand ball in place.

Using a portable source of vacuum, check the system for sealed vacuum. Sealed vacuum at the valve should not vary more than three to five inches from the sealed vacuum at the power unit.

Typical Pipe Runs

Down orientation on two floors.

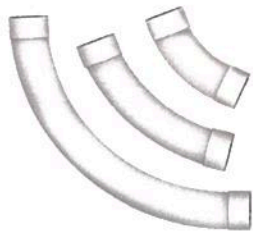
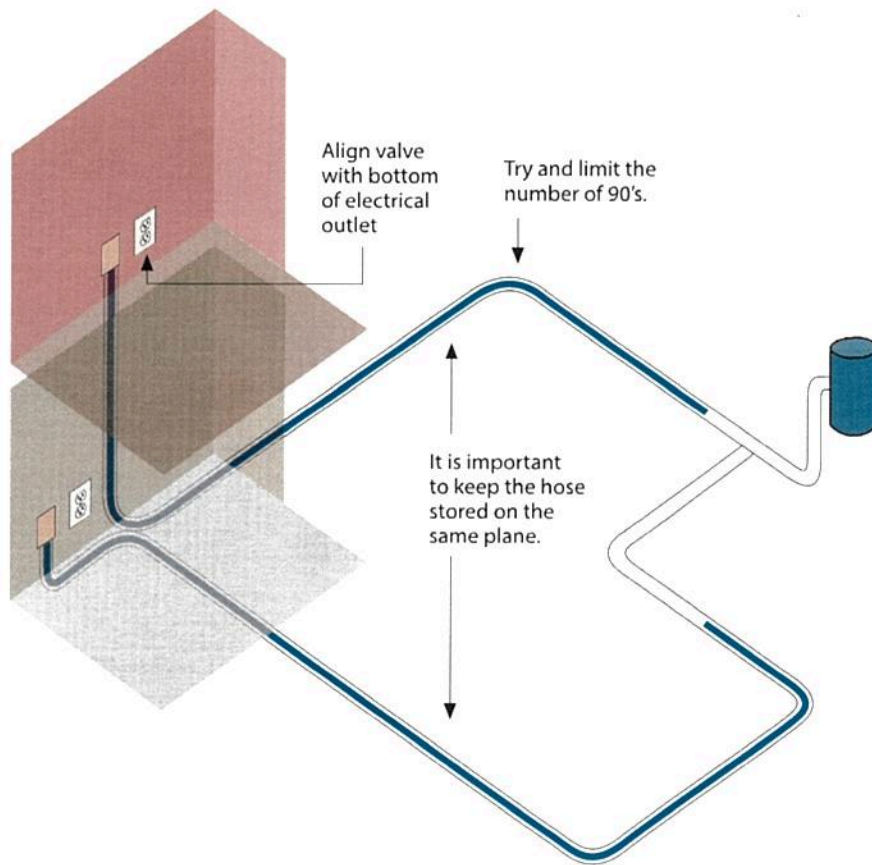

Only Hide-a-Hose special sweep 90's, 45's, and 22.5's can be in the section of pipe that stores the hose.

Typical Pipe Runs

Up orientation on two floors.

In order to ensure enough pipe to store the hose, the pipe runs will sometimes need to begin running away from the power unit, then make a loop and head back toward the power unit.

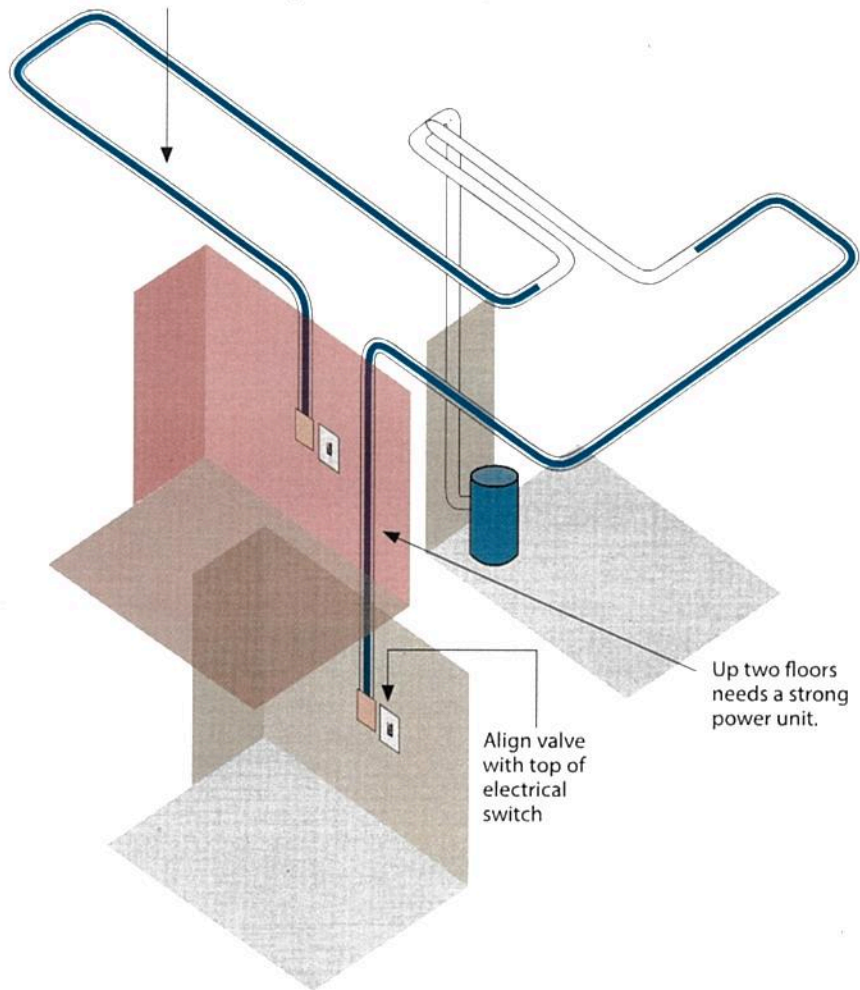

Trim

A lubricant has already been applied to the o-ring on the pipe fitting.

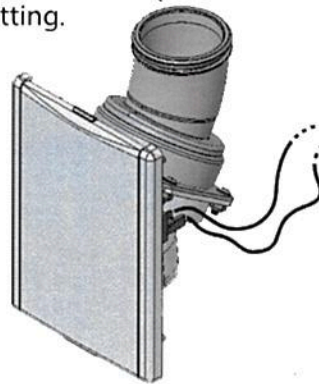

Using wire nuts, connect the two leads from the switch that is mounted on the outside of the valve to the low voltage wire.

The pointed tabs are only used in retrofitting existing homes. (See Retrofit section)

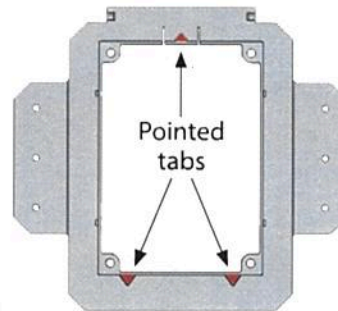

Insert the valve assembly into the rough-in frame.

Align the four holes in the valve assembly with the holes in the frame. Secure with the four screws included in the trim kit.

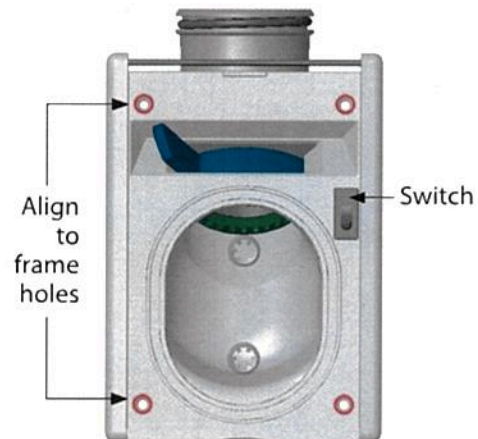

Retrofit an Existing Home

Use the mud cover as a template to cut the hole.

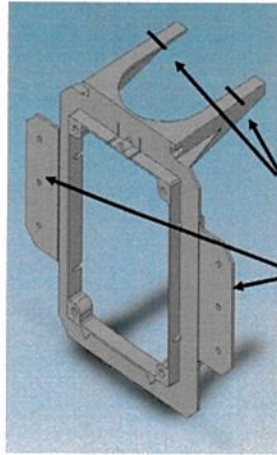

To allow the frame to fit through the valve hole in the sheetrock, cut approximately 3/4" (1.9 cm) off the forks.

You will need to score and cut off both of the mounting tabs in order for the rough-in frame to fit in the hole.

Insert the Rough-in frame horizontally. Then turn it back upright behind the wall.

Push the bottom two pointed tabs into the sheetrock. The top pointed tab can be bent down as you pull the top of the frame into the hole. The tabs will help hold the frame in place while you install the valve. You may need to push a couple of small finish nails, horizontally into the sheetrock, through the holes located on the side of the frame.

Installation of pipe runs and trim can follow same instructions as for new construction.

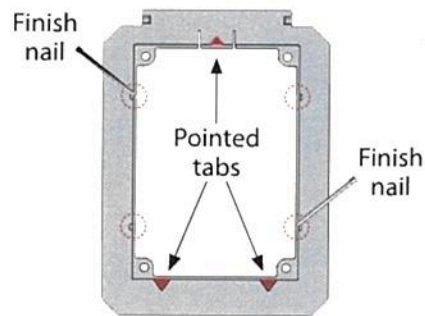

Addendum

Important Information for Installing the HS5000 valve in a Down Orientation

Avoid Potential Issue

One of the advantages of the HS5000 is that it can adjust for wall thicknesses from 1/2" to 1 1/2". As shown in Figure 1, with 1/2" sheetrock, the pipe fitting is pushed all the way to the back of the wall. Problems can arise when the bottom hole is too far forward. The pipe is too short to flex enough, thus putting a large amount of pressure on the back of the valve. We have actually seen valves break under these extreme conditions.

Solution

Drill a larger hole (2 9/16") to allow the pipe to have some movement (see Figure 2). Before installing the valve, reach in and make sure the pipe can flex forward and back inside the wall. Sometimes the foam insulation will need to be broken up with a long screwdriver.

If you find that it is going to require a lot of force to push the pipe back, it is a good idea to put a shim between the pipe and the front wall board, to take the pressure off of the valve, as shown in Figure 1.

